

Universal In-Line Slate Ventilator

Installation details and cutting templates

Underlay and batten cutting

Trim the central batten and fix nailing/skew nailing support battens as shown. Ensure the underlay is tacked to the battens when folded back to maintain the integrity of the roof.

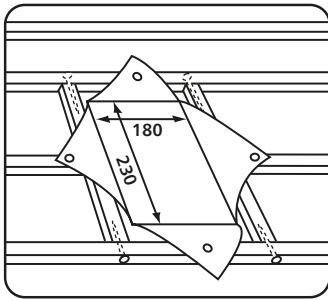

For TOP slates use cutting template 1
For BOTTOM slates use cutting template 2

TOP SLATES

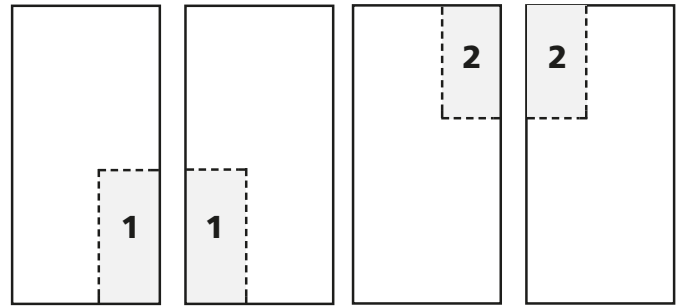

BOTTOM SLATES

95mm

95mm

SLATE CUTTING TEMPLATE

1

FOR THE TOP SLATES

Slate Size	Headlap	Approximate Cut Length
600 x 300mm	100mm	110mm
600 x 300mm	75mm	100mm
500 x 250mm	100mm	160mm
500 x 250mm	75mm	150mm
450 x 230mm	100mm	185mm
450 x 230m	75mm	175mm

SLATE CUTTING TEMPLATE

2

FOR THE BOTTOM SLATES

Slate Size	Headlap	Approximate Cut Length
600 x 300mm	100mm	250mm
600 x 300mm	75mm	240mm
500 x 250mm	100mm	200mm
500 x 250mm	75mm	190mm
450 x 230mm	100mm	175mm
450 x 230mm	75mm	165mm

Cut lengths will vary according to slate size, gauge and headlap

Installation details and cutting templates

Fixing instructions

1. Marking the Battens The position of the slate vent must be located between rafters. The middle batten at the vent position must be cut to allow installation therefore trimmer or support battens should be fitted. This batten should be cut to allow for a minimum gap of 200mm after fixing the support battens, as shown in Fig 1.

2. Fixing the Support Battens Trim the central batten and fix by nailing/skew nailing support battens as shown in Fig 2 for 450 x 230mm slates. When using slates longer than 450mm, it is recommended that an additional support batten is fixed across the rafters and between the main battens to provide fixing for the support battens and to support the head of the vent. Fig 3a. Cut the diagonals of a 230mm x 180mm rectangle in the underlay, fold out the flaps and tack to the surrounding battens to deflect and prevent water and debris ingress through the underlay. Fig 2.

3. Cutting the Slates Slate up to the course below where the vent is to be fitted. Trim the two slates to be located under the vent using Template 2 marked 'BOTTOM SLATES' supplied with the ventilator, allowing for any variations due to differing headlaps and slate sizes and fix as shown in Figs 3 and 3a.

4. Positioning the Vent Fit the vent into the aperture created by the cut slates and the corresponding aperture cut into the roof underlay. Fix the adjacent slates ensuring that they overlap the vent base as shown to maintain the bond and creep angle.

Trim the top two slates to be fitted over the vent using the template supplied marked TOP and fix as shown in Fig 4 for 450 230mm slates. When using slates longer and wider than this size, half a slate should be fitted over the head of the ventilator to maintain adequate headlap. To allow nailing of the next course of slate over the vent, which should be cut around the vent grille area, a double batten is required above the vent. Fig 4a.

5. Slating Continue to slate the roof in the normal manner. Fig 5.

6. Sark Board Details Common Scottish practice is to nail slates and ancillaries direct to the sark boards through the roof underlay. In order to ensure a snug fit between the vent, sark board and the underlay a 260mm deep x 200mm wide aperture should be cut into the sark board and the underlay. The underlay should be cut diagonally 260mm deep x 200mm wide (as described in Section 2) and an aperture cut in the sark board to the same dimensions. The triangular flaps of the underlay are folded back and should be tacked to the sarking to help maintain the integrity of the roof.

7. Soil Ventilation and Mechanical Extraction When using the vent for either soil ventilation or mechanical extraction it is necessary to first of all fit the adapter kit (ILSPA) to the vent. The complete assembly can then be fixed into position Fig 6. When fitting the adapter to the spigot make sure that it is pushed home firmly – the adapter should be the correct way round to the spigot – ensuring that the four locator pins on the vent are fully secured into the holes in the adapter. Any pipework passing through a cold roof being used for mechanical extraction should be lagged to minimise condensation forming on the inside of the pipe.

Fig 1

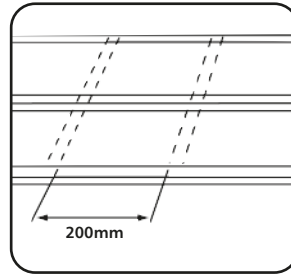

Fig 2

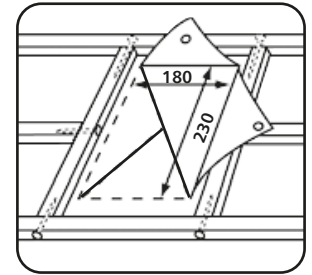

Fig 3

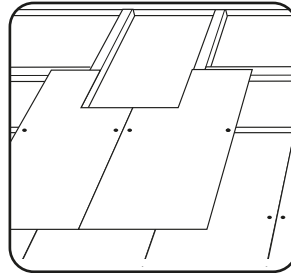

Fig 3a

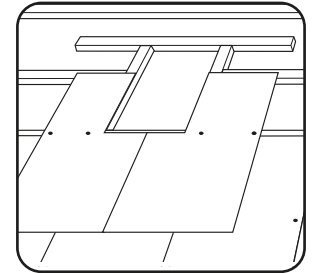

Fig 4

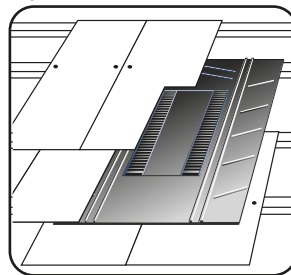

Fig 4a

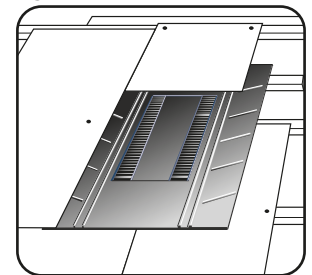

Fig 5

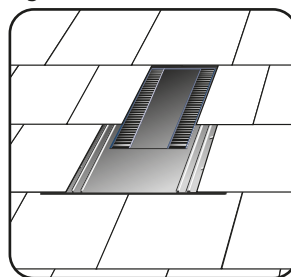

Fig 6

